

※ 下課鐘響前不得繳卷

班級：

座號：

姓名：

P1

請將答案寫在答案欄中，否則不予計分!

第一大題 聽力測驗 15%

一、 辨識句意：每題均有三張圖片，請依據所聽到的句子，選出符合描述的圖片

1. _____

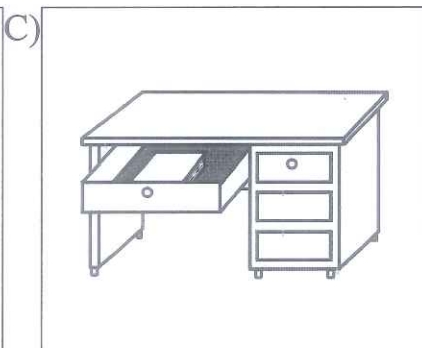
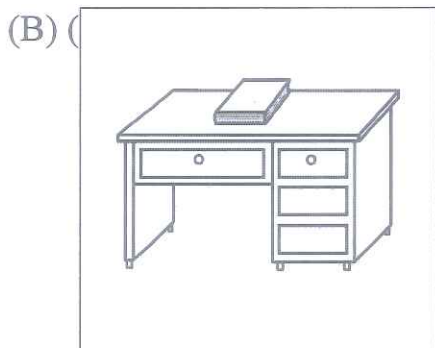
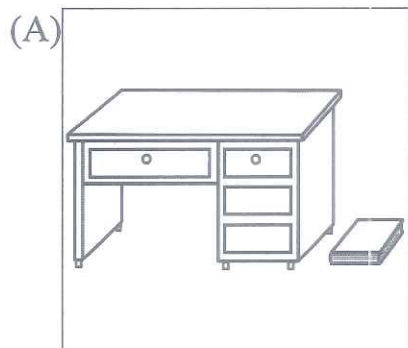

2. _____

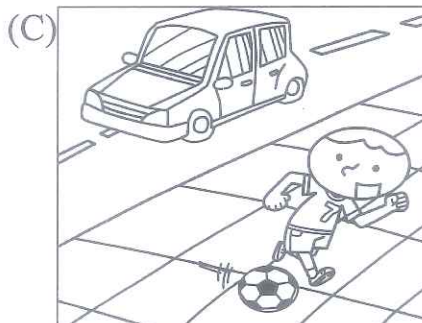
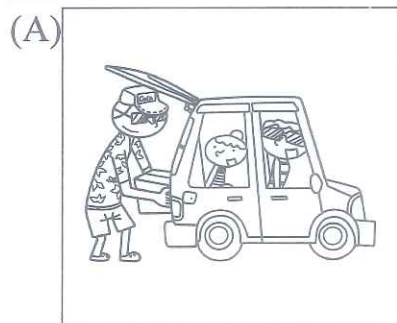

3. _____

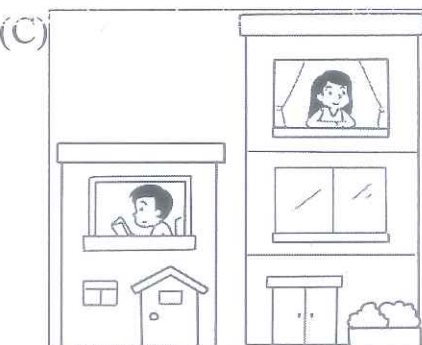
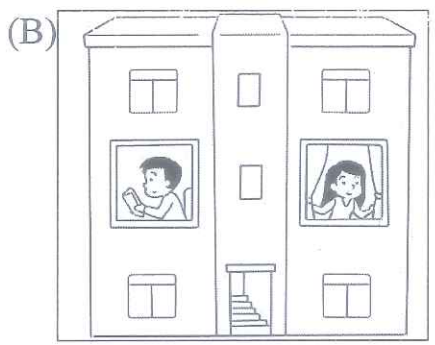
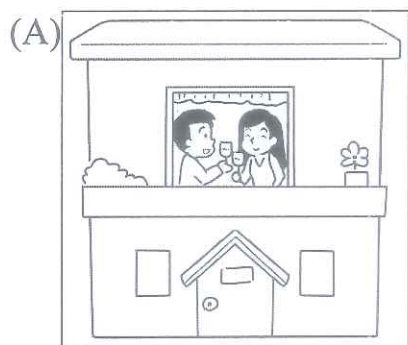

4. _____

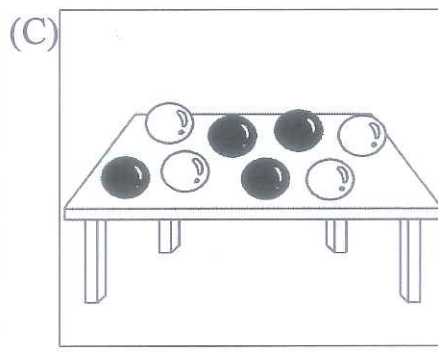
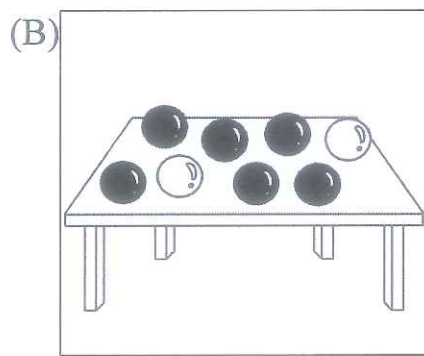
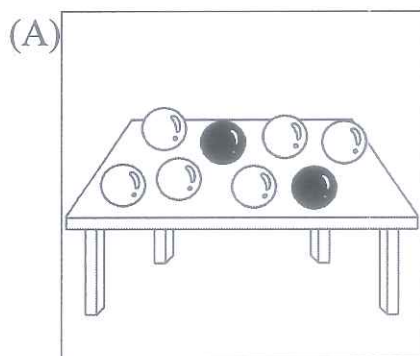

5. _____

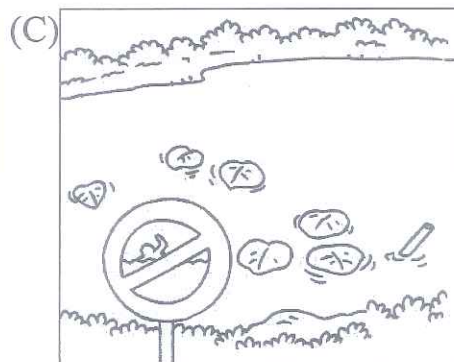
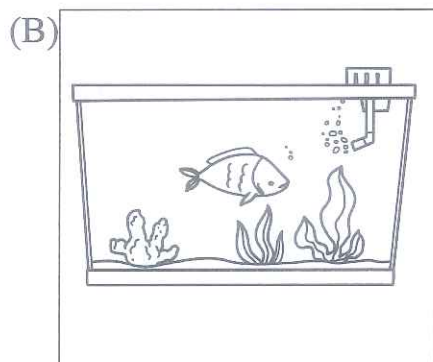
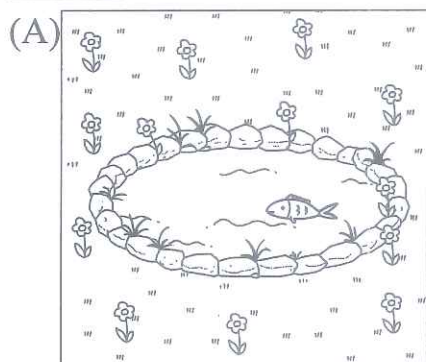

※ 下課鐘響前不得繳卷

班級：

座號：

姓名：

P2

二、 基本問答：每題均有三個選項，請依據所聽到的內容，選出一個最適合的回應

1. _____
(A) No, she is in the kitchen.
(B) No, she is in the living room.
(C) No, she is not in the bedroom.
2. _____
(A) It's hard.
(B) Yes, it's soft.
(C) My sofa is yellow.
3. _____
(A) It's scary.
(B) That's right.
(C) Where is it?
4. _____
(A) No, there aren't.
(B) Yes, it's on the sofa.
(C) No, it's a living room.
5. _____
(A) Yes, there is one in the afternoon.
(B) Yes, there are lots of basketballs here.
(C) Yes, there is a basketball court in the park.

三、 言談理解：每題均有三個選項，請依據所聽到的對話與問題，選出一個最適當的答案

1. _____
(A) In the bathroom.
(B) Near the kitchen.
(C) In his wife's house.
2. _____
(A) The red blanket is thin and soft.
(B) The yellow blanket is not small.
(C) The man's blanket is red and yellow.
3. _____
(A) Eric and Terri are roommates.
(B) Terri's bed is in Eric bedroom.
(C) Terri is in Eric's bedroom now.
4. _____
(A) Yes, there are some foxes in the zoo.
(B) No, the red foxes are in the playground.
(C) Yes, there are monkeys in the zoo.
5. _____
(A) There is a pond in the castle.
(B) There is a lake near the castle.
(C) There isn't a pond in the castle.

背面尚有試題

※ 下課鐘響前不得繳卷

班級：

座號：

姓名：

P3

第二大題 單字專區(1-5 中翻英；6-10 文意字彙)15% (1-5 題，每題 1 分;6-10 題，每題 2 分)

1. 飯廳 2. 圍繞;到處 3. 體育館 4. 或者 5. 故事書

- _____ 6. Some books and n_____rs are on the table. My father is reading(讀) them.
 _____ 7. Lisa's English is good, so her English g_____es are good, too.
 _____ 8. A: Where is the kitchen? B: It's under the s_____rs.
 _____ 9. There are no students at school. Let's close (我們關上) the school g_____e.
 _____ 10. Your face (臉) is dirty(髒). Go to(去) the r_____m and wash(洗) it!

第三大題 文法選擇 20%

- () 1. A: Is there a big screen on your new cellphone? B: _____.
 (A) Yes, it is. (B) Yes, there are. (C) Yes, I have. (D) Yes, there is.
- () 2. A: Where is your father? B: He is _____ there, and he is playing with (和...玩) our pet rabbit.
 (A) X (B) not (C) at (D) next
- () 3. A: How old is your cousin, Tina? B: She is _____ girl.
 (A) an eight year old (B) an-eight-year-old (C) an eight-year-old (D) an eight years old
- () 4. A: Robert, is your bed soft or hard? B: _____.
 (A) It's very soft. (B) It's not a hard sofa. (C) Yes, it's very hard. (D) No, it's not soft.
- () 5. A: _____ there any libraries near your home?
 B: Yes, there _____ some near my home.
 (A) Aren't ; is (B) Are ; are (C) Aren't ; isn't (D) Are ; aren't
- () 6. My _____ and I are very happy because there are some great _____ at our school.
 (A) classmates ; class (B) classmate ; classes (C) classmate; class (D) classes; classes
- () 7. There are _____ playgrounds near the school.
 (A) a lot of (B) a lot (C) lot of (D) lots
- () 8. A: Is there _____ horse at the zoo? B: Yes. And _____ very cute!
 (A) one ; there is (B) the ; there is (C) some ; it is (D) a ; it is
- () 9. Look! This is _____ bedroom. They are roommates.
 (A) Bella's and Lisa (B) Bella's and Lisa's (C) Bella and Lisa's (D) Bella and Lisa
- () 10. A: _____ there in the pond? B: There are some fish in it.
 (A) Who is (B) Where is (C) What is (D) How is

第四大題 依提示作答 9%

1. Where are the boys? (用「在籃球場」回答)
2. There are some cellphones on the desk. (用 any 改寫此句)
3. The school is next to the lake, and it is next to the tree, too. (用 between 改寫句子，句意不變)

背面尚有試題

※ 下課鐘響前不得繳卷

班級：

座號：

姓名：

P4

第五大題 翻譯 11%(一格一分;句子一題三分)

1. Harry Potter 在學校是為了魔法考試而非樂趣。

Harry Potter is at school for _____, not for _____.

2. 在運動場前面沒有車子。There isn't a car in front of the _____.

3. 在世界上的房子都不一樣。The houses in the _____.

4. 你最喜愛的地方是什麼？是我家。(What...? It...)

第六大題 核心素養閱讀專區 20%

A.

Andy: Welcome to my house.
 Ariel: Wow. Your house is big and beautiful. (1) are your parents?
 Andy: My mother is busy in the kitchen, and my dad is drinking some tea (喝茶) in the living room. Look! It's my bedroom.
 Ariel: Your bedroom is big, and your bed is soft. How old is it?
 Andy: (2), it is new. It's only (只有) one year old.
 Ariel: What about the small bed (3) your bed?
 Andy: It's for my pet cat, Mimi.
 Ariel: Mimi? That's a cute name! And where is it?
 Andy: Oh, it is (4) the house now. It will be (將會) at home (5).

- () 1. (A) How old (B) Who (C) Where (D) What
- () 2. (A) Wrong again (B) That's right (C) Thank you very much (D) In fact
- () 3. (A) over (B) at (C) near (D) to
- () 4. (A) in (B) outside (C) at (D) to
- () 5. (A) twenty minutes later (B) twenty later minutes (C) later twenty minutes (D) later minutes twenty

B.

Bella: Are your parents at home today?
 Nick: No, they aren't. My (6) family are at my grandfather and grandmother's home.
 Bella: Are there (7) special things today?
 Nick: Yes, it's my grandfather's birthday.
 Bella: (8) is he?
 Nick: He is 88.
 Bella: Wow, it's a big day for your grandfather!
 Nick: That's right.
 Bella: (9) is their house? Is it near a lake?
 Nick: No, it's (10).

- () 6. (A) whole (B) junior (C) happy (D) old
- () 7. (A) these (B) some (C) any (D) those
- () 8. (A) What about (B) How tall (C) What school (D) How old
- () 9. (A) Where (B) Who (C) What (D) How
- () 10. (A) near a lake (B) in front of the koalas (C) on the dining room (D) next to a pond

背面尚有試題

※ 下課鐘響前不得繳卷

班級：

座號：

姓名：

P5

C. This is the seat chart (座位表) of Class 710.

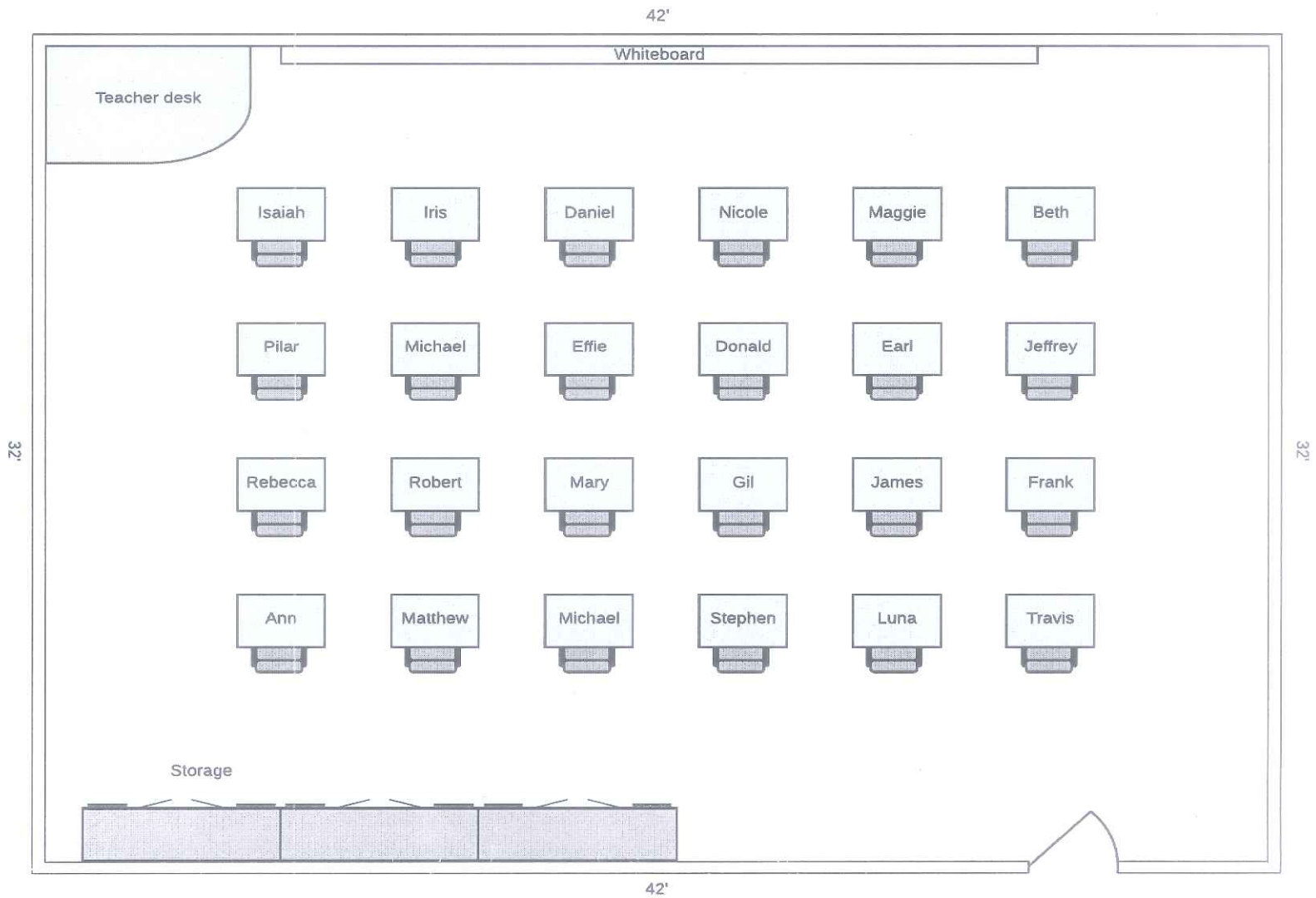

- () 11. Where is the storage(置物櫃)?
 (A) It's near the teacher's desk.
 (B) It's behind the students' desks.
 (C) It's between the doors.
 (D) It's next to the whiteboard(白板).
- () 12. Where is James?
 (A) He is behind Maggie and Earl.
 (B) He is next to Jeffrey.
 (C) He is near Rebecca.
 (D) He is in front of Ann.
- () 13. How many(多少) students are there in Class 710?
 (A) There are fourteen.
 (B) There twenty-four.
 (C) There are thirty-four.
 (D) There are forty-four.
- () 14. There is a student near the teacher's desk, next to Daniel, and in front of Michael.
 Who is this student?
 (A) Nicole.
 (B) Effie.
 (C) Iris.
 (D) Isaiah.
- () 15. Are there any whiteboards(白板) in this classroom?
 (A) Yes. It's the students' whiteboard.
 (B) Yes. There are two blackboards.
 (C) Yes. It's in front of the classroom.
 (D) Yes. There is one in it.

※ 下課鐘響前不得繳卷

班級：

座號：

姓名：

06

D.

Hi, everyone. Welcome to our school—Chung Cheng Junior High School. I am the principal, Mr. Huang.

This school is in the mountains and near a park—Chung Cheng Park. In this school, you can see the Keelung Harbor. The view is very beautiful from here.

This year, there are ninety boys and eight-five girls in the 7th grade. There are many kinds of classes for them. We have eight classes in a day. The first class is at 8:20, and the school is over at 16:45.

There is a special class—“On Book Joy Band”. It is a place for the students after school. Students do their homework over there.

There are some clubs for your kids, too. These clubs are very interesting. Our club teachers are great.

Our school is a good place for your kids, and every student is important to our school!

Welcome to this big family!

* principal 校長 can see 可以看見 Keelung Harbor 基隆港 view 景色
the 7th grade 七年級 many kinds of 許多種類 the first 第一的
over 結束 after school 放學後 do homework 寫功課
club 社團 kid 小孩 interesting 有趣的 every 每一個 important 重要的

- () 16. Who is “everyone”?
- (A) Teachers.
(B) Parents.
(C) Kids.
(D) Mr. Huang.
- () 17. There are _____ at Chung Cheng Junior High School.
- (A) 95 boys and 85 girls
(B) 90 boys and 85 girls
(C) 85 boys and 90 girls
(D) 95 boys and 80 girls
- () 18. What is “On Book Joy Band”?
- (A) It’s a special book.
(B) It’s a special class.
(C) It’s a special club.
(D) It’s a special school.
- () 19. Where is Chung Cheng Junior High School.?
- (A) It’s near a mountain.
(B) It’s under the harbor.
(C) It’s near Chung Cheng Park.
(D) It’s behind the mountains.
- () 20. What does “this big family” mean(意指)?
- (A) Keelung Harbor.
(B) Chung Cheng Park.
(C) On Book Joy Band.
(D) Chung Cheng Junior High School.

※ 下課鐘響前不得繳卷

班級：

座號：

姓名：

P7

答案欄

| | | |
|----|----|---|
| 口說 | 讀寫 | 總 |
| 分數 | 分數 | 分 |
| | | |

第一大題 聽力測驗 15%

一 辨識句意

| | | | | |
|---|---|---|---|---|
| 1 | 2 | 3 | 4 | 5 |
|---|---|---|---|---|

二 基本問答

| | | | | |
|---|---|---|---|---|
| 1 | 2 | 3 | 4 | 5 |
|---|---|---|---|---|

三 言談理解

| | | | | |
|---|---|---|---|---|
| 1 | 2 | 3 | 4 | 5 |
|---|---|---|---|---|

第二大題 單字專區 15% (1-5 題每題 1 分; 6-10 題每題 2 分)

1 _____ 2 _____ 3 _____ 4 _____ 5 _____
 6 _____ 7 _____ 8 _____ 9 _____ 10 _____

第三大題 文法選擇 20%

| | | | | | | | | | |
|---|---|---|---|---|---|---|---|---|----|
| 1 | 2 | 3 | 4 | 5 | 6 | 7 | 8 | 9 | 10 |
|---|---|---|---|---|---|---|---|---|----|

第四大題 依提示作答 9%

1. Where are the boys? (用「在籃球場」回答)

2. There are some cellphones on the desk. (用 any 改寫此句)

3. The school is next to the lake, and it is next to the tree, too. (用 between 改寫句子，句意不變)

第五大題 翻譯 11% (1~8 一格一分; 句子一題三分)

1. Harry Potter 在學校是為了魔法考試而非樂趣。

Harry Potter is at school for _____, not for _____.

2. 在運動場前面沒有車子。There isn't a car in front of the _____.

3. 在世界上的房子都不一樣。The houses in the _____.

4. 你最喜愛的地方是什麼？是我家。(What...? It...)

第六大題 核心素養閱讀專區 20%

| | | | | |
|----|----|----|----|----|
| 1 | 2 | 3 | 4 | 5 |
| 6 | 7 | 8 | 9 | 10 |
| 11 | 12 | 13 | 14 | 15 |
| 16 | 17 | 18 | 19 | 20 |